

TYPE	Base Speed	Power kW	Frequency (Hz)			Voltage		Absorption		
	rpm		Min	Base	Max	Base	Optional	A (220v)	A (380v)	
HMA 55	12000	0,20	150	200	300	220	380	220/380	1,44	0,84
HMA 60	12000	0,22	150	200	300	220	380	220/380	1,50	0,87
HMA 70	12000	0,35	150	200	300	220	380	220/380	2,00	1,16
HMA 85	12000	0,37	150	200	300	220	380	220/380	2,20	1,20
HMA 95	12000	0,55	150	200	300	220	380	220/380	2,60	1,50
HMA 115	12000	0,75	150	200	300	220	380	220/380	3,80	2,20
HMA 55	18000	0,25	200	300	360	220	380	220/380	1,60	0,92
HMA 60	18000	0,27	200	300	360	220	380	220/380	1,90	1,10
HMA 70	18000	0,45	200	300	360	220	380	220/380	2,40	1,40
HMA 85	18000	0,55	200	300	360	220	380	220/380	3,20	1,80
HMA 95	18000	0,75	200	300	360	220	380	220/380	3,70	2,20
HMA 115	18000	1,10	200	300	360	220	380	220/380	5,10	3,00
HMA 55	24000	0,25	250	400		220	380	220/380	1,60	0,92
HMA 60	24000	0,27	250	400		220	380	220/380	1,90	1,10
HMA 70	24000	0,45	250	400		220	380	220/380	2,40	1,40
HMA 85	24000	0,55	250	400		220	380	220/380	3,20	1,80
HMA 95	24000	0,75	250	400		220	380	220/380	3,70	2,20
HMA 115	24000	1,10	250	400		220	380	220/380	5,10	3,00

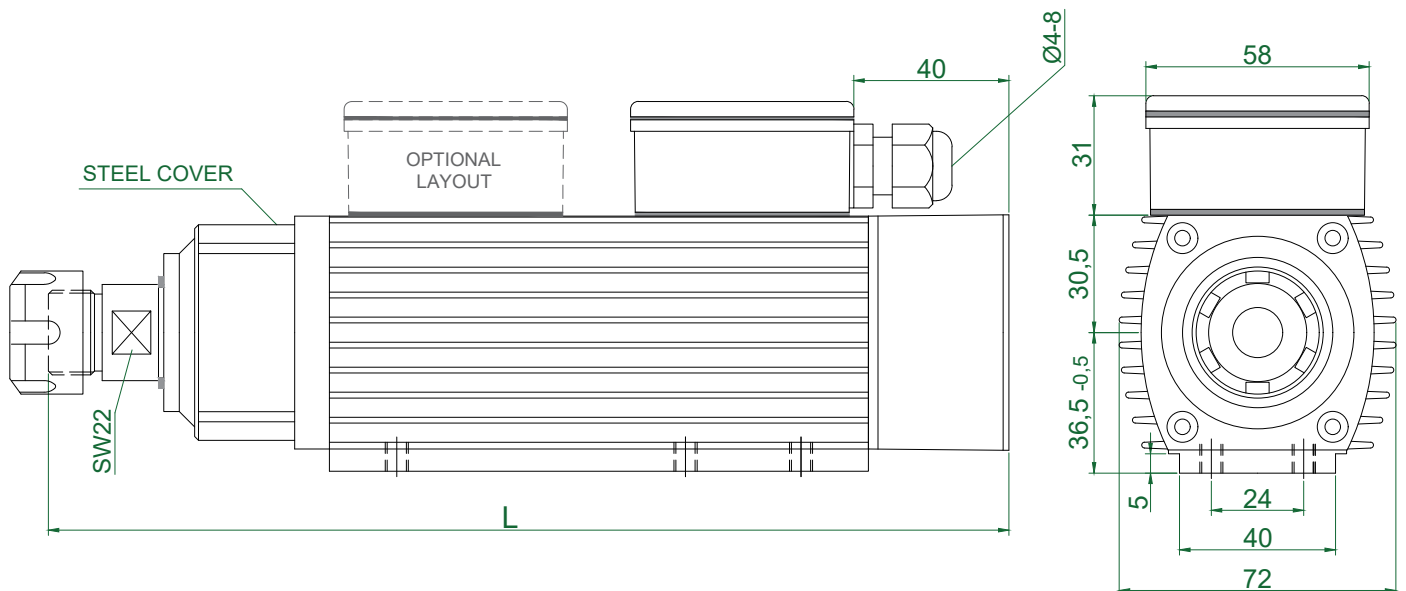

TYPE	A1	A2	L	Apr. Weight Kg
HMA 55_ER16S-CK-1R	60	-	210	2,300
HMA 60_ER16S-CK-1R	60	-	215	2,350
HMA 70_ER16S-CK-1R	75	-	225	2,450
HMA 85_ER16S-CK-1R	75	-	240	2,800
HMA 95_ER16S-CK-1R	75	-	250	3,000
HMA 115_ER16S-CK-1R	75	30	270	3,350

Plug Connection
(optional)

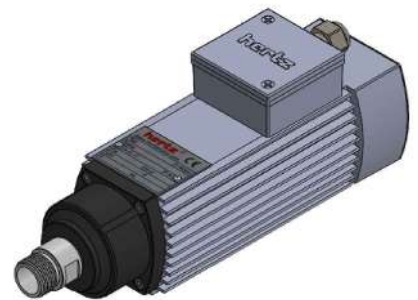
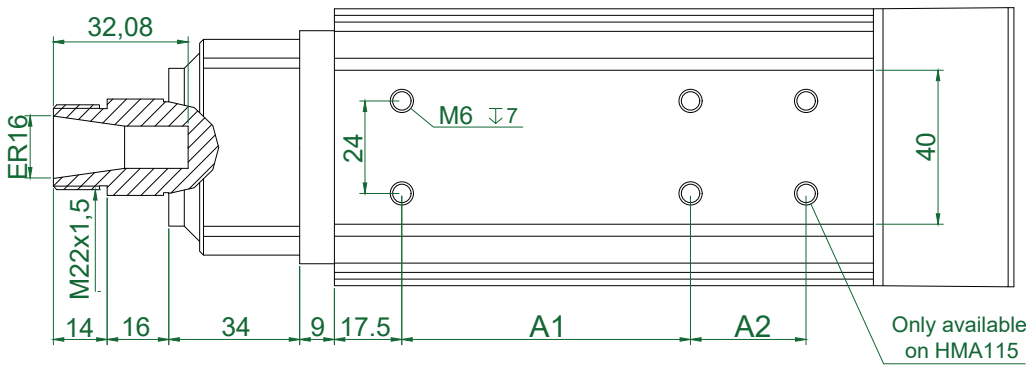