

TYPE	Base Speed	Power kW	Frequency (Hz)			Voltage			Absorbion	
	rpm		Min	Base	Max	Base	Optional	A (220v)	A (380v)	
HM90-10	3000	1,00	40	50	75	380	220	220/380	4,90	2,90
HM90-14	3000	1,35	40	50	75	380	220	220/380	5,90	3,30
HM90-17	3000	1,50	40	50	75	380	220	220/380	6,50	3,80
HM90-10	6000	2,20	70	100	180	220	380	220/380	9,50	5,50
HM90-14	6000	3,50	70	100	180	380	220	220/380	13,0	7,50
HM90-17	6000	4,00	140	200	360	380	220	220/380	16,4	9,50
HM90-10	12000	3,50	150	200	300	380	220	220/380	13,00	7,50
HM90-14	12000	4,00	150	200	300	380	220	220/380	16,40	9,50
HM90-14	12000	4,50	150	200	300	380	220	220/380	18,0	9,90
HM90-17	12000	5,50	150	200	300	380	220	220/380	19,8	11,4

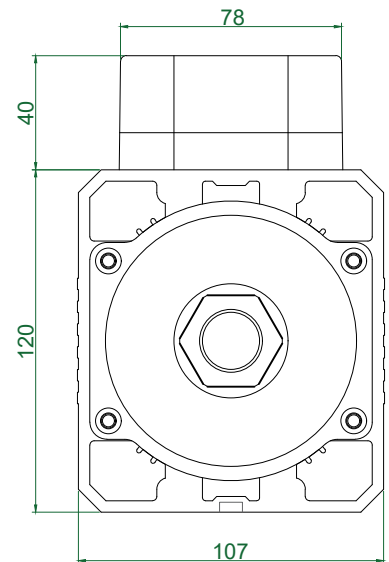

TYPE	L	Apr. Weight Kg
HM90.10_FL30.88.12M-CK-2R	322	12,000
HM90.14_FL30.88.12M-CK-2R	362	14,150
HM90.17_FL30.88.12M-CK-2R	392	15,650

PLUG CONNECTION
(optional)

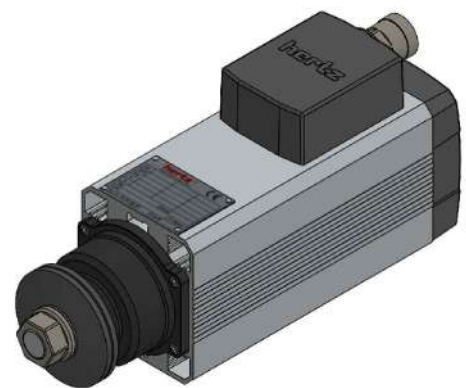
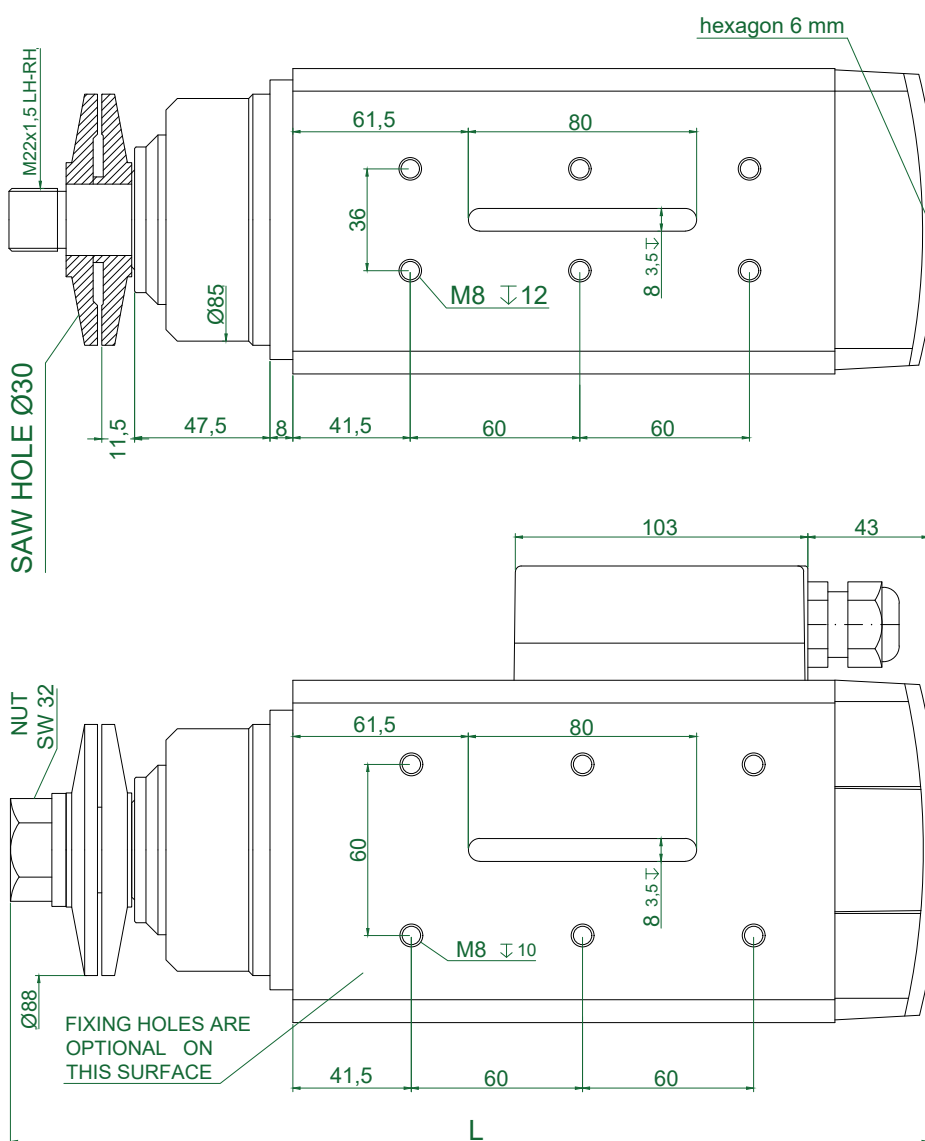