

TYPE	Base Speed	Power	Frequency (Hz)			Voltage		Absorption		
	rpm		Min	Base	Max	Base	Optional	A (220v)	A (380v)	
HM110-10	3000	2,20	40	50	75	220	380	220/380	9,50	5,50
HM110-12	3000	3,00	40	50	75	380	220	220/380	12,5	7,20
HM110-10	6000	3,00	140	200	360	380	220	220/380	12,5	7,20
HM110-10	6000	3,00	70	100	180	380	220	220/380	12,5	7,20
HM110-10	6000	4,00	140	200	360	380	220	220/380	16,4	9,50
HM110-10	6000	4,00	70	100	180	380	220	220/380	16,4	9,50
HM110-12	6000	5,50	140	200	360	380	220	220/380	19,8	11,40
HM110-12	6000	5,50	70	100	180	380	220	220/380	19,8	11,40
HM110-10	12000	4,00	300	400	600	380	220	220/380	16,4	9,50
HM110-10	12000	4,00	150	200	300	380	220	220/380	16,4	9,50
HM110-10	12000	5,50	300	400	600	380	220	220/380	19,8	11,40
HM110-10	12000	5,50	150	200	300	380	220	220/380	19,8	11,40
HM110-12	12000	7,50	300	400	600	380	220	220/380	28,7	16,6
HM110-12	12000	7,50	150	200	300	380	220	220/380	28,7	16,6

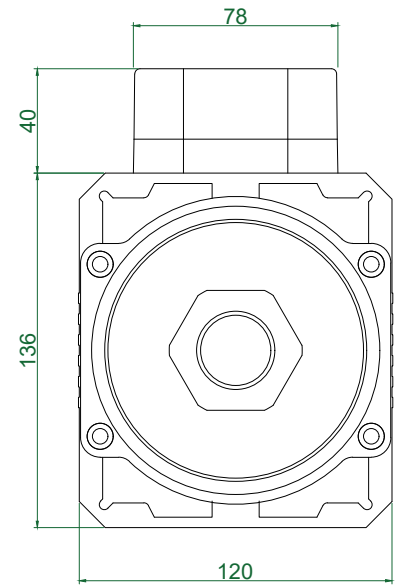
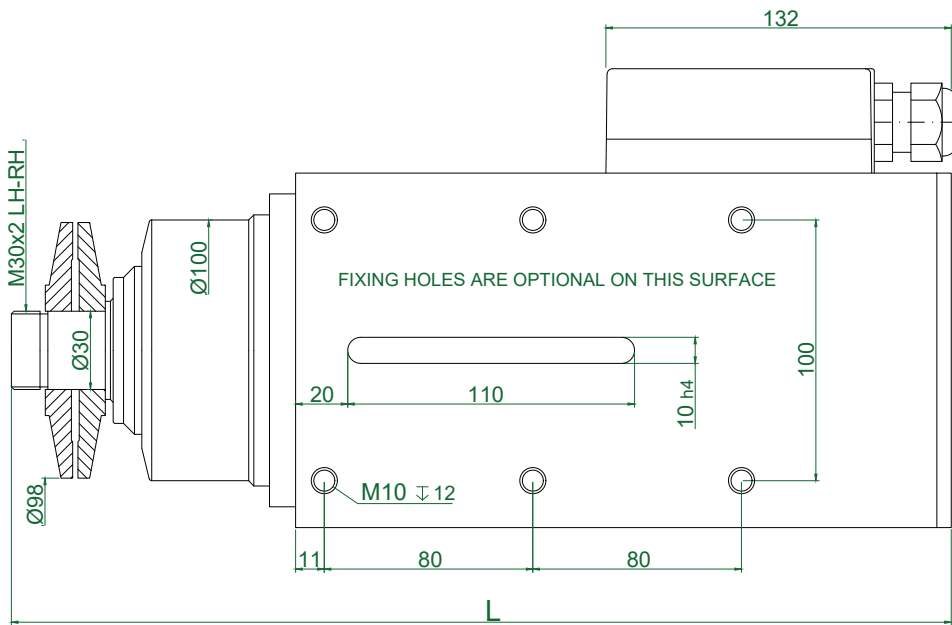
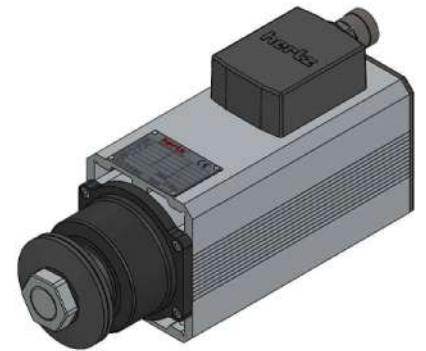
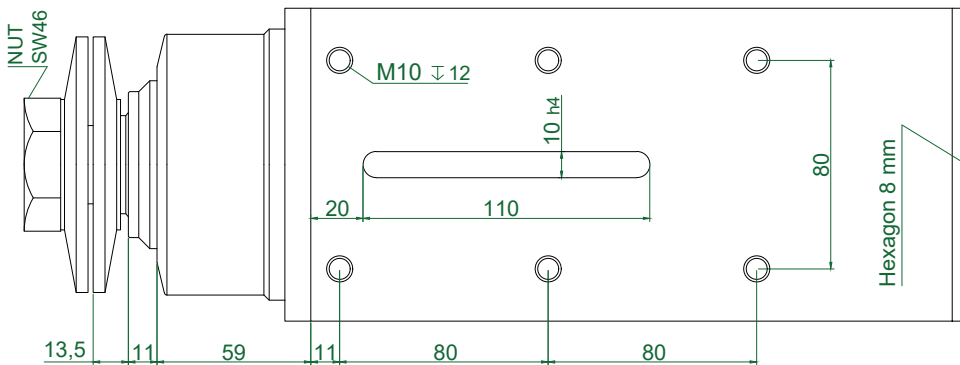

TYPE	L	Apr. Weight Kg
HM110.10_FL30.98.14M-CK-2R	341	17,400
HM110.12_FL30.98.14M-CK-2R	361	18,700